

# FONTANA SINKS

Made From DuPont™ Corian®



distributors of

DuPont™  
**CORIAN®**  
SOLID SURFACES

# FONTANA SINKS

Made From DuPont™ Corian®

The sink is at the heart of every kitchen, both in terms of design and functionality. Our superb Fontana sinks combine DuPont™ Corian® with the highest quality stainless steel to offer endless possibilities for the modern kitchen.

Fontana sinks are hygienic and easy to clean. The stainless steel base easily withstands boiling liquid and hot pots and pans. Because Fontana sinks are available in all the Corian® kitchen colours, the sink can be integrated into a matching Corian® worktop for the ultimate in contemporary kitchen style.

Made in Germany, Fontana sinks carry the standard DuPont™ Corian® 10-year limited installed warranty.



distributors of

DuPont™  
**CORIAN®**  
SOLID SURFACES



## SINGLE SINKS

FSP-30

FSP-15

FSP-50

- Heat resistant high quality stainless steel base
- 12.3mm wall thickness
- Internal corners are thermoformed to maximise strength
- Lira waste kit included
- Available with or without overflow
- CNC files and templates available on request
- Available in all the Corian® kitchen colours

**FSP-30**  
317 x 413 x 190mm  
R13

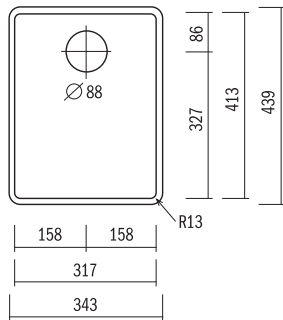

**FSP-15**  
148 x 317 x 140mm  
R13

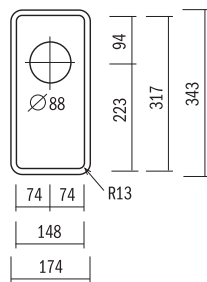

**FSP-50**  
507 x 413 x 190mm  
R13

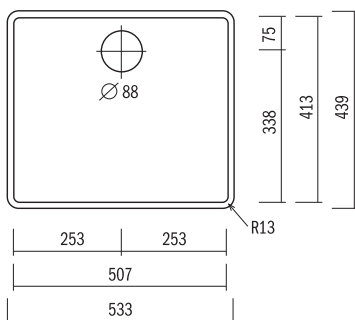

# FONTANA SINKS

Made From DuPont™ Corian®



## SINGLE SINKS

FSP-40

FSP-12R

FSP-12L

- Heat resistant high quality stainless steel base
- 12.3mm wall thickness
- Internal corners are thermoformed to maximise strength
- Lira waste kit included
- Available with or without overflow
- CNC files and templates available on request
- Available in all the Corian® kitchen colours

**FSP-40**  
390 x 400 x 190mm

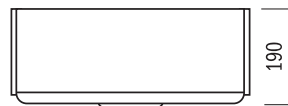
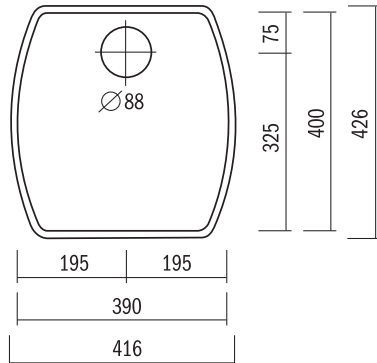

**FSP-12R**  
**FSP-12L**  
103 x 300 x 120mm

Available either left or right hand

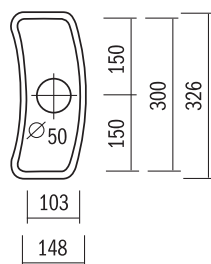



## SINGLE SINKS - R60

FSP-851

FSP-853

FSP-41

- Heat resistant high quality stainless steel base
- 12.3mm wall thickness
- Internal corners are thermoformed to maximise strength
- Lira waste kit included
- Available with or without overflow
- CNC files and templates available on request
- Available in all the Corian® kitchen colours

**FSP-851**  
317 x 413 x 190mm  
R60

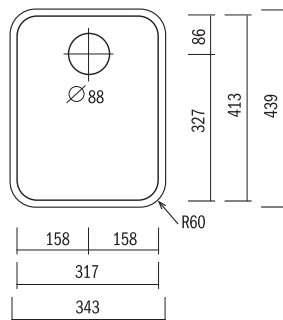

**FSP-853**  
168 x 352 x 150mm  
R60

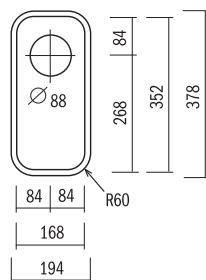

**FSP-41**  
415 x 190mm

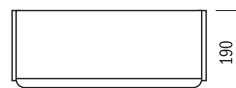
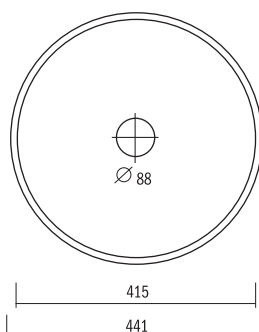

# FONTANA SINKS

Made From DuPont™ Corian®



## SINGLE SINKS

FSP-35

FSP-44

- Heat resistant high quality stainless steel base
- 12.3mm wall thickness
- Internal corners are thermoformed to maximise strength
- Lira waste kit included
- Available with or without overflow
- CNC files and templates available on request
- Available in all the Corian® kitchen colours

Only available from 1st March 2009

**FSP-35**  
240 x 350 x 140mm  
R13

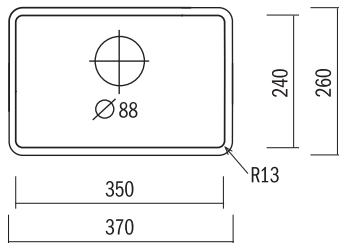

**FSP-44**  
413 x 413 x 210mm  
R13

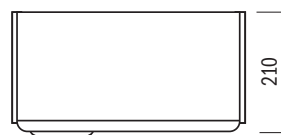
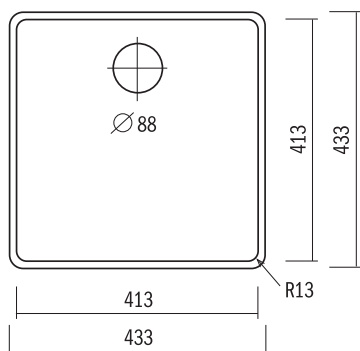



## TWIN SINKS

**FSP-851853**

**FSP-5035**

**FSP-3015**

- Heat resistant high quality stainless steel base
- 12.3mm wall thickness
- Internal corners are thermoformed to maximise strength
- Lira waste kit included
- Available with or without overflow
- CNC files and templates available on request
- Available in all the Corian® kitchen colours

**FSP-851853**

R60

**851**

317 x 413 x 190mm

**853**

168 x 352 x 150mm

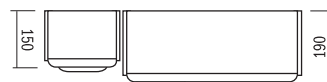
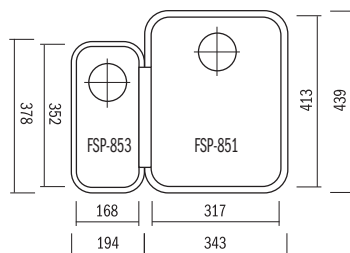

**FSP-5035**

R60

**50**

507 x 413 x 190mm

**35**

240 x 350 x 140mm

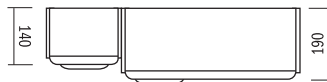
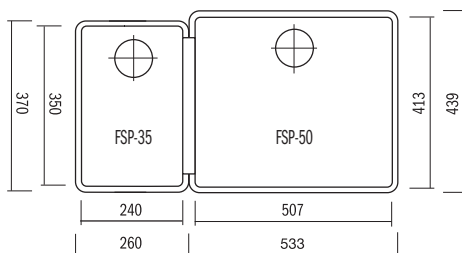

**Only available from 1st March 2009**

**FSP-3015**

R13

**30**

317 x 413 x 190mm

**15**

148 x 317 x 140mm

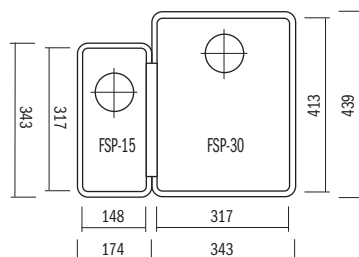

**CD(UK)LTD**

Thistle House, Thistle Way, Gildersome Spur,  
Wakefield Road, Morley, Leeds LS27 7JZ.

Telephone: 0113 201 2240 Fax: 0113 253 0717

Direct Order Telephone: 0113 201 2244 Fax: 0113 289 7300

**web: [www.cdukltd.co.uk](http://www.cdukltd.co.uk) email: [info@cdukltd.co.uk](mailto:info@cdukltd.co.uk)**

Corian® is a registered trade mark of DuPont™



Certificate No. 6796